



SCALE

COLOR:  WHITE  IVORY  GRAY  BROWN  
 NOTE: FIRST LETTER OF COLOR FOLLOWS PART NUMBER.

**SITE ESTIMATOR**

JOB DESCRIPTION



















**PART**

3 1/2" W x 2 1/2" D

**QTY**

4 1/2" W x 3 1/4" D

**QTY**

	Ducting (8ft lengths)	LD-92	<input type="checkbox"/>	LD-122	<input type="checkbox"/>
	Coupler	LJ-92	<input type="checkbox"/>	LJ-122	<input type="checkbox"/>
	Wall Inlet	LW-92	<input type="checkbox"/>	LW-122	<input type="checkbox"/>
	Soffit Inlet	LP-92	<input type="checkbox"/>	LP-122	<input type="checkbox"/>
	End Fitting	LEN-92	<input type="checkbox"/>	LEN-122	<input type="checkbox"/>
	90° Flat Ell	LK-92	<input type="checkbox"/>	LK-122	<input type="checkbox"/>
	45° Flat Ell	LKF-92	<input type="checkbox"/>	LKF-122	<input type="checkbox"/>
	90° Inside Vertical Ell	LCI-92	<input type="checkbox"/>	LCI-122	<input type="checkbox"/>
	90° Outside Vertical Ell	LCO-92	<input type="checkbox"/>	LCO-122	<input type="checkbox"/>
	45° Inside Vertical Ell	LCFI-92	<input type="checkbox"/>	LCFI-122	<input type="checkbox"/>
	45° Outside Vertical Ell	LCFO-92	<input type="checkbox"/>	LCFO-122	<input type="checkbox"/>
	Tee	LT-92	<input type="checkbox"/>	LT-122	<input type="checkbox"/>
	Reducer	LDR-92	<input type="checkbox"/>	LDR-122	<input type="checkbox"/>
	90° Sweep Ell	LKS-92	<input type="checkbox"/>	LKS-122	<input type="checkbox"/>
	Flexible Ell	LF-92	<input type="checkbox"/>	LF-122	<input type="checkbox"/>
	Flexible Adaptor	LFJ-92	<input type="checkbox"/>	LFJ-122	<input type="checkbox"/>
	Flexible Wall Flange	LWF-92	<input type="checkbox"/>	LWF-122	<input type="checkbox"/>
	Wall Sleeve	LWS-92 3 1/4 O.D.	<input type="checkbox"/>	LWS-122 4 1/4 O.D.	<input type="checkbox"/>
	Twistlock Lineset duct clips (100 Qty) fits both 92 & 122				

See back side for lineset size and capacity ►

Typical lineset\* capacity LD-92 3 1/2" W x 2 1/2" D

LD-122 4 1/2" W x 3 1/4" D

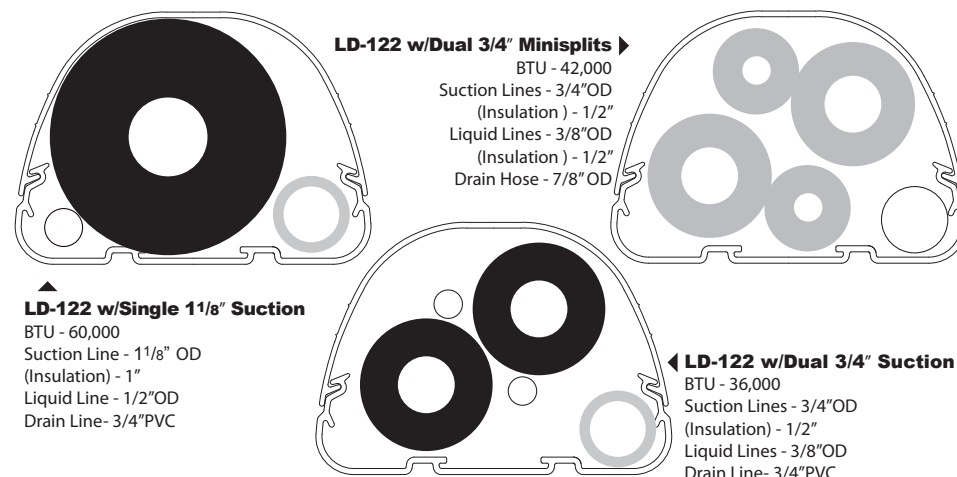
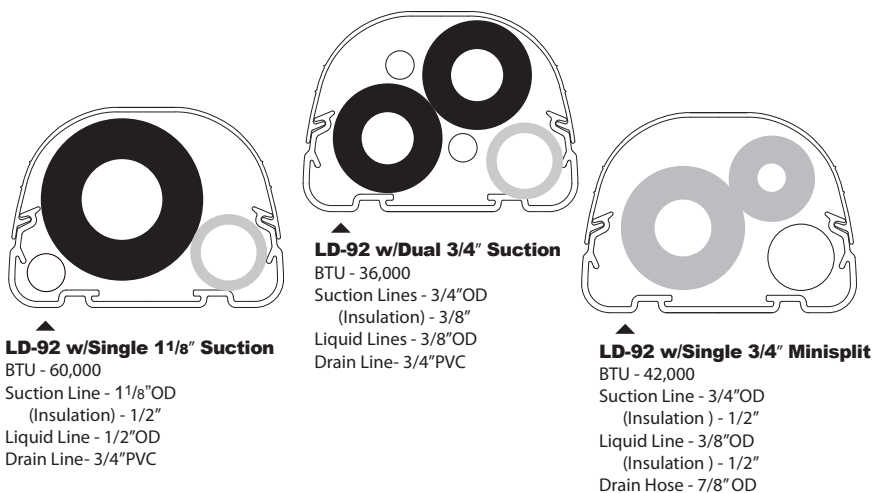

\* Lineset size may change on Seer Rating

## Specialty fitting installation instructions

### Flexible fitting

#### INLINE COUPLING

- Secure fitting and duct bases to wall.
- Cut LF duct to length and place in fitting.
- Secure LF duct with split cap and two screws.
- Secure duct into coupler by fitting second part of cap.

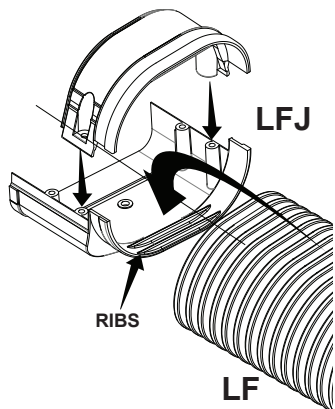

#### WALL CONNECTION

- Seal and attach wall flange to wall.
- Place LF duct into fitting.
- Clamp LF duct with cap and two screws.

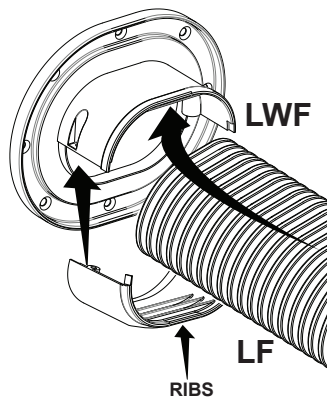

### End fitting

End fitting provides critical support to the lineset duct cover. Without this fitting, the duct cover can slide out of place.

To adjust the opening to suit lineset size, simply snip the end fitting along the desired groove, and break off unwanted sections.

A coupling can also be utilized at the duct end for larger lineset fill.

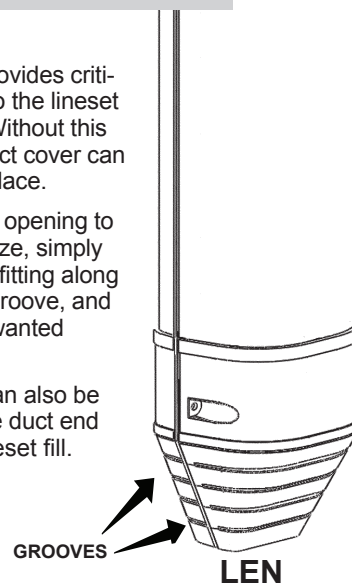

### Wall Sleeve

- Using a hole saw, drill a hole at the desired point of penetration.
- Secure LW base over hole.
- Insert LWS sleeve into hole.
- Install lineset.
- Seal and attach LW cover.

